TEST REPORT NO.: N3E14-105R0318-001

ISSUE NO.: 1

CE EMC TEST REPORT

TESTING

OF

Digital LCD Sealing Iron

Model : 1365

FOR

PROLUX HOBBY INDUSTRY CO., LTD.

Issued by

Precision Machinery Research & Development Center

No.27, 37th Road Taichung Industrial Park, Taichung, Taiwan, R.O.C.

Tel : 886-4-23599009 Fax : 886-4-23598847



EMC TEST REPORT

Applicant : PROLUX HOBBY INDUSTRY CO., LTD.
No.80, Sec. 3, Hansi E Road, Beitun Dist., Taichung City, Taiwan
(R.O.C.)

Manufacturer : PROLUX HOBBY INDUSTRY CO., LTD.
No.80, Sec. 3, Hansi E Road, Beitun Dist., Taichung City, Taiwan
(R.O.C.)

Product Name : Digital LCD Sealing Iron

Main Model : 1365

Series Models : 1365GB, 136X(X=0~9), 136XGB(X=0~9)

Test Power : 1 ϕ AC 230V, 50 Hz

Test Standard : EN 55014-1 : 2006/A2 : 2011
EN 55014-2 : 1997/A2 : 2008 (Category II)

Test Date : 2016/02/17 and 2016/02/18

Test Result : **PASS**

Test Laboratory : PMC Electromagnetic Compatibility Testing Laboratory
No.27, 37th Road, Taichung Industrial Park, Taichung, Taiwan, R.O.C.
TEL: +886-4-2359-9009 FAX:+886-4-2359-8847

Tested by Lee Hsin Chang

Signature

March 21, 2016

Date

Approved by Tim Hise

March 21, 2016

Date

Note :

1. The test results only responds to the tested sample, and is invalid as separately used.
2. The test results are invalid without examination stamp and signature of this laboratory.
3. The test results are not reproduced except in full without the written approved of PMC Lab.

Table of Contents

1. GENERAL DESCRIPTION OF EUT	6
1.1 THE WORST CASE FOR TESTING EVALUATION.....	6
1.2 COUNTERMEASURE	6
1.3 DESCRIPTION OF MODEL.....	6
2. GENERAL INFORMATION OF TEST	7
2.1 SUMMARY OF TEST RESULT	7
2.2 MEASUREMENT UNCERTAINTY	7
2.3 PERFORMANCE CRITERIA OF IMMUNITY TEST	8
2.4 TEST EQUIPMENT	9
3. CONDUCTED EMISSION TEST.....	11
3.1 LIMITS OF TERMINAL DISTURBANCE VOLTAGE	11
3.2 TEST SETUP.....	11
3.3 ENVIRONMENTAL CONDITIONS.....	12
3.4 DESCRIPTION OF THE TEST	12
3.5 TEST RESULT	12
3.6 PHOTO DURING THE TEST	15
4. RADIATED EMISSION TEST	16
4.1 LIMITS OF TERMINAL DISTURBANCE VOLTAGE	16
4.2 TEST SETUP.....	16
4.3 ENVIRONMENTAL CONDITIONS.....	17
4.4 DESCRIPTION OF THE TEST	17
4.5 TEST RESULT	17
4.6 PHOTO DURING THE TEST	19
5. DISCONTINUOUS DISTURBANCE.....	20
5.1 REFERENCE STANDARD.....	20
5.2 TEST SETUP.....	20
5.3 ENVIRONMENTAL CONDITIONS.....	20
5.4 DESCRIPTION OF THE TEST	21
5.5 TEST RESULT	21
5.6 PHOTO DURING THE TEST	24

6. HARMONICS ON AC MAINS	25
6.1 LIMITS FOR HARMONIC CURRENT EMISSION (CLASS A).....	25
6.2 TEST SETUP.....	25
6.3 ENVIRONMENTAL CONDITIONS.....	25
6.4 DESCRIPTION OF THE TEST	26
6.5 TEST RESULT	26
6.6 PHOTO DURING THE TEST	28
7. VOLTAGE FLUCTUATION ON AC MAINS	29
7.1 LIMITS	29
7.2 TEST SETUP.....	29
7.3 ENVIRONMENTAL CONDITIONS.....	29
7.4 DESCRIPTION OF THE TEST	29
7.5 TEST RESULT	30
7.6 PHOTO DURING THE TEST	30
8. ELECTROSTATIC DISCHARGE IMMUNITY TEST.....	31
8.1 TEST SPECIFICATION AND PERFORMANCE CRITERIA.....	31
8.2 TEST SETUP.....	31
8.3 ENVIRONMENTAL CONDITIONS.....	32
8.4 DESCRIPTION OF THE TEST	32
8.5 TEST RESULT	32
8.6 PHOTO DURING THE TEST	34
9. ELECTRICAL FAST TRANSIENT/BURST IMMUNITY TEST	35
9.1 TEST SPECIFICATION AND PERFORMANCE CRITERIA.....	35
9.2 TEST SETUP.....	35
9.3 ENVIRONMENTAL CONDITIONS.....	36
9.4 DESCRIPTION OF THE TEST	36
9.5 TEST RESULT	36
9.6 PHOTO DURING THE TEST	37
10. IMMUNITY TEST OF CONDUCTED DISTURBANCES INDUCED BY RADIO— FREQUENCY FIELDS	38
10.1 TEST SPECIFICATION AND PERFORMANCE CRITERIA.....	38

10.2 TEST SETUP.....	38
10.3 ENVIRONMENTAL CONDITIONS.....	39
10.4 DESCRIPTION OF THE TEST	39
10.5 TEST RESULT	39
10.6 PHOTO DURING THE TEST	40
11. SURGE IMMUNITY TEST.....	41
11.1 TEST SPECIFICATION AND PERFORMANCE CRITERIA.....	41
11.2 TEST SETUP.....	41
11.3 ENVIRONMENTAL CONDITIONS.....	42
11.4 DESCRIPTION OF THE TEST	42
11.5 TEST RESULT	42
11.6 PHOTO DURING THE TEST	43
12. VOLTAGE DIP AND VOLTAGE VARIATIONS IMMUNITY TEST	44
12.1 TEST SPECIFICATION AND PERFORMANCE CRITERIA.....	44
12.2 TEST SETUP.....	44
12.3 ENVIRONMENTAL CONDITIONS.....	45
12.4 DESCRIPTION OF THE TEST	45
12.5 TEST RESULT	45
12.6 PHOTO DURING THE TEST	46

Attachment : Photograph of EUT

Attachment : Electronic Diagram of EUT

Laboratory Information

Precision Machinery Research & Development Center(PMC) was founded by government and Taiwan Association of Machinery Industry, established on June 1st, 1993. We are a non-profit organization to help manufacturers to value up the products and comply with the EMC and Safety requirement.

And, our facilities and ability of measurement are approved by the following organizations and countries.

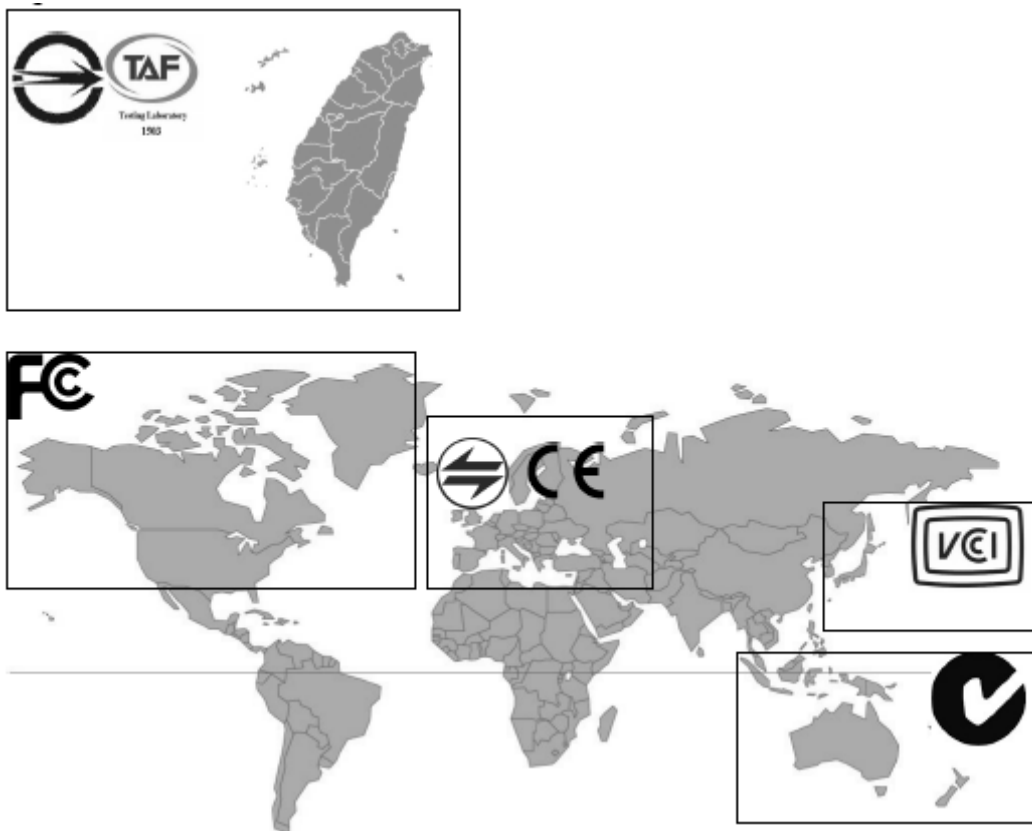

If you have any comments, please don't hesitate to contact us. Our contact information is as below:

PMC Testing Laboratory :

No.27, 37th Road Taichung Industrial Park, Taichung, Taiwan, R.O.C.

TEL:+886-4-2359-9009 #312 / FAX:+886-4-2359-8847

1. General Description of EUT

1.1 The worst case for testing evaluation

After estimating, PMC found the heating executes at continuously would be the worst case for testing.

1.2 Countermeasure

N/A.

1.3 Description of model

The difference between serial models and main model is only sale marketing and the electronic diagram and heater are the same. After estimating, We (PMC) had executed the model 1365 for EMC tests. According these test results, we estimate the series models could be adapted the results.

Remark :

1365, 136X (X=0~9) the plug for EURO market

1365GB, 136XGB (X=0~9) the plug for United Kingdom market

2. General Information of Test

2.1 Summary of Test Result

Electro-Magnetic Interference		
Standard	Edition	Comment
EN 55014-1	2006/A2 : 2011	PASS
EN61000-3-2	2006/A2:2009	PASS
EN61000-3-3	2013	PASS
Electro-Magnetic Susceptibility		
Standard	Edition	Comment
EN 55014-2	1997/A2 : 2008	PASS
EN 61000-4-2	2006/A2 : 2010	PASS
EN 61000-4-4	2004/A1 : 2010	PASS
EN 61000-4-5	2006	PASS
EN 61000-4-6	2009	PASS
EN 61000-4-11	2004	PASS

2.2 Measurement Uncertainty

The Conducted Emission Test Site is 3.1dB.

The Radiated Emission Test Site is 4.94dB.

The reported uncertainty of measurement $y \pm U$, where expanded uncertainty U is based on a standard uncertainty multiplied by a coverage factor of $k=2$, providing a level of confidence of approximately **95%**.

measurement instrumentation uncertainty considerations contained in CISPR 16-4-2.

2.3 Performance Criteria of Immunity Test

Performance Criterion A :

The equipment shall continue to operate as intended without operator intervention. No degradation of performance or loss of function is allowed below a performance level specified by the manufacturer when the equipment is used as intended. The performance level may be replaced by a permissible loss of performance.

Performance Criterion B :

After the test, the equipment shall continue to operate as intended without operator intervention. No degradation of performance or loss of function is allowed after the application of the phenomena below a performance level specified by the manufacturer, when the equipment is used as intended. During the test, degradation of performance is allowed. However, no change of actual operating state or stored data is allowed to persist after the test.

Performance Criterion C :

Loss of function is allowed, provided the function is self recoverable or can be restored by the operation of the controls by the user in accordance with the manufacturer instructions.

2.4 Test equipment

Item	Brand / Model	Series No.	Calibration Due	Used
EMI Test Receiver	ROHDE & SCHWARZ ESCS 30	847793/004	27, Jul., 2016	<input checked="" type="checkbox"/> Used
Bilog Antenna	CHASE CBL 6111B	2085	28, Jul., 2016	<input checked="" type="checkbox"/> Used
L.I.S.N.	SCHWARZBECK MESS-ELEKTRONIK NNLK8129	8129129	26, Jan., 2017	<input checked="" type="checkbox"/> Used
Power Clamp	MDS-21	848818/012	25, Jan., 2017	<input checked="" type="checkbox"/> Used
Harmonic and Flicker Analyzer	EM TEST/ DPA 500	V0503100065	29, Apr., 2016	<input type="checkbox"/> Used
ESD Test Unit	EM TEST/ESD 30C	V0822103834	15, Jul., 2016	<input checked="" type="checkbox"/> Used
Signal Generator	ROHDE & SCHWARZ/SMY01	844934/058	10, Dec., 2016	<input checked="" type="checkbox"/> Used
Signal Generator	Agilent/N5181A	4037U03276	18, Dec., 2016	<input type="checkbox"/> Used
Power Amplifier	KALMUS/747LC	8680-1	20, Dec., 2016	<input checked="" type="checkbox"/> Used
EFT Test Unit	EM TEST/EFT 500	0596-32	24, Aug., 2016	<input checked="" type="checkbox"/> Used
Surge Generator	EM TEST/VCS 500	0397-09	24, Aug., 2016	<input checked="" type="checkbox"/> Used
6 dB Attenuator	BNOS ELECTRONICS	522055	20, Dec., 2016	<input checked="" type="checkbox"/> Used
CDN	FCC/801-M3-25A	05033	16, Nov., 2016	<input checked="" type="checkbox"/> Used

Item	Brand / Model	Series No.	Calibration Due	Used
PFMF Generator	EM TEST/MC26100	N/A	10, Jun., 2016	<input type="checkbox"/> Used
PFMF Antenna	EM TEST/MS100	N/A	10, Jun., 2016	<input type="checkbox"/> Used
Mobile Phone	NOKIA 3840	0500811	N/A	<input type="checkbox"/> Used
Wireless Router	D-Link/DIR-300	P1DY18C003321	N/A	<input type="checkbox"/> Used
B.C.I.	FCC	F-140A	30, Apr, 2016	<input type="checkbox"/> Used
FM Transmitter	ICOM/IC-W32E	86AR0069	N/A	<input type="checkbox"/> Used
Power Fail Simulator	EM TEST/PFS 503	0897-03	08, Dec., 2016	<input checked="" type="checkbox"/> Used

3. Conducted Emission Test

3.1 Limits of terminal disturbance voltage

Standard	Frequency range MHz	Limit values dBuV	
		Quasi-peak	Average
EN 55014-1 2006/A2:2011	0.15 to 0.5	66-56 ^a	59-46 ^a
	0.5 to 5	56	46
	5 to 30	60	50

a. Decreasing linearly with logarithm of the frequency.

3.2 Test setup

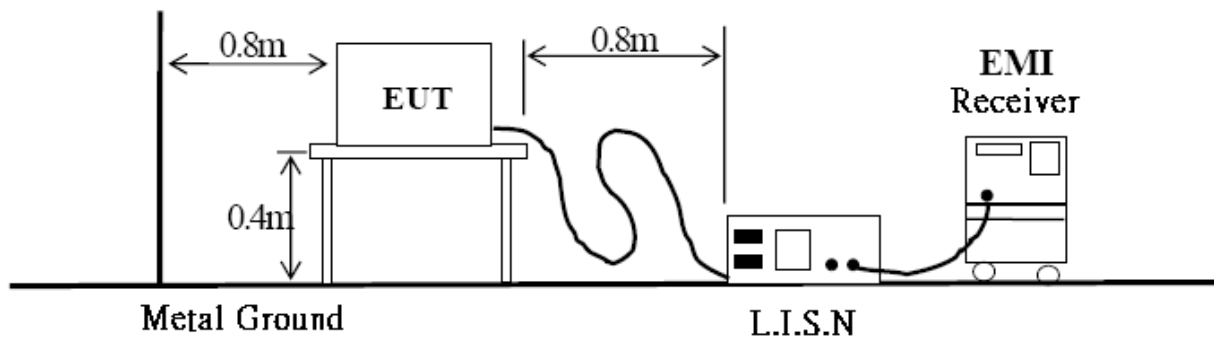

3.3 Environmental conditions

Test Date	Ambient Temperature	Relative Humidity	Atmospheric Pressure
Feb. 17, 2016	24.3 °C	53.2 %	1012 mbar

3.4 Description of the test

1. The test was carried out on the EUT broadly in accordance with EN 55014-1.
2. The reading on the measuring receiver is observed for about 15s each measurement; the highest readings shall be recorded with the exception of any isolated spike which shall be ignored.
3. The registered values shall be given at least at the following frequencies: 160kHz, 240kHz, 550kHz, 1MHz, 1.4MHz, 2MHz, 3.5MHz, 6MHz, 10MHz, 22MHz and 30MHz, these frequencies are to be subject to a tolerance of $\pm 10\%$.

3.5 Test result

The following pages show the results of conducted emission.

Judging from these data, it is reasonable to assume that the EUT would pass the test to the limits defined in EN 55014-1 over the frequency range 0.15 MHz to 30 MHz.

EMC Log Sheet of CE Test-L1 Phase

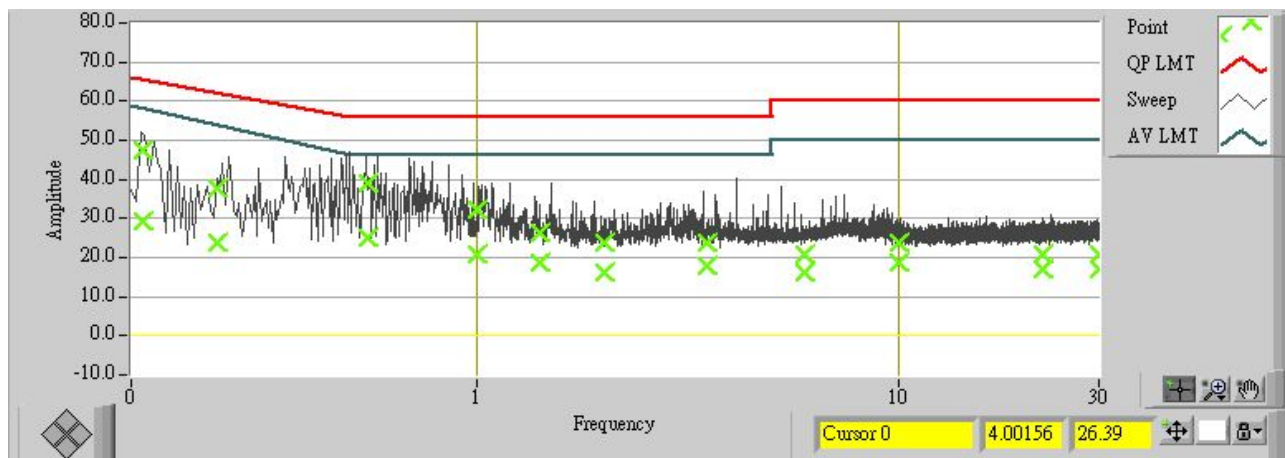

No.	Freq. (MHz)	Reading (dBuV)	Factor (dB)	Result (dBuV)	Limit (dBuV)	Margin (dB)	Remark
1	0.160	37.70	9.88	47.58	65.46	-17.88	QP
2	0.160	19.42	9.88	29.30	58.30	-29.00	AV
3	0.240	27.87	9.87	37.74	62.10	-24.36	QP
4	0.240	13.99	9.87	23.86	53.93	-30.07	AV
5	0.550	29.32	9.82	39.14	56.00	-16.86	QP
6	0.550	15.32	9.82	25.14	46.00	-20.86	AV
7	1.000	22.24	9.81	32.05	56.00	-23.95	QP
8	1.000	10.87	9.81	20.68	46.00	-25.32	AV
9	1.400	16.66	9.82	26.48	56.00	-29.52	QP
10	1.400	8.79	9.82	18.61	46.00	-27.39	AV
11	2.000	13.77	9.83	23.60	56.00	-32.40	QP
12	2.000	6.56	9.83	16.39	46.00	-29.61	AV
13	3.500	13.83	9.85	23.68	56.00	-32.32	QP
14	3.500	8.01	9.85	17.86	46.00	-28.14	AV
15	6.000	10.76	9.88	20.64	60.00	-39.36	QP
16	6.000	6.33	9.88	16.21	50.00	-33.79	AV
17	10.000	14.03	9.93	23.96	60.00	-36.04	QP
18	10.000	9.00	9.93	18.93	50.00	-31.07	AV
19	22.000	10.99	9.95	20.94	60.00	-39.06	QP
20	22.000	7.08	9.95	17.03	50.00	-32.97	AV
21	30.000	11.11	9.94	21.05	60.00	-38.95	QP
22	30.000	7.29	9.94	17.23	50.00	-32.77	AV

EMC Log Sheet of CE Test-L2 Phase

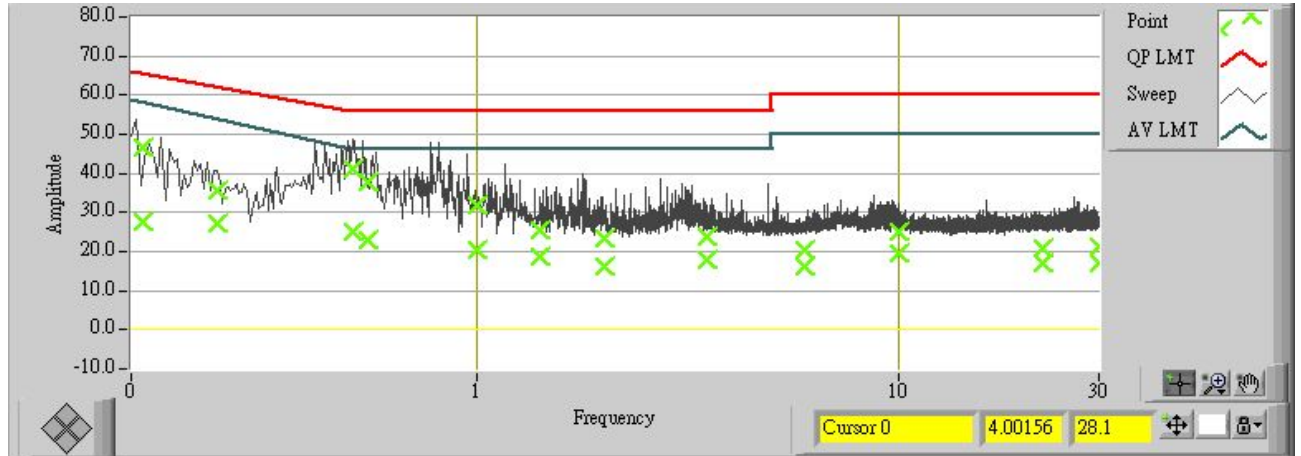

No.	Freq. (MHz)	Reading (dBuV)	Factor (dB)	Result (dBuV)	Limit (dBuV)	Margin (dB)	Remark
1	0.160	36.74	9.88	46.62	65.46	-18.84	QP
2	0.160	17.88	9.88	27.76	58.30	-30.54	AV
3	0.240	25.87	9.87	35.74	62.10	-26.36	QP
4	0.240	17.23	9.87	27.10	53.93	-26.83	AV
5	0.505	31.26	9.82	41.08	56.00	-14.92	QP
6	0.505	15.32	9.82	25.14	46.00	-20.86	AV
7	0.550	27.82	9.82	37.64	56.00	-18.36	QP
8	0.550	13.28	9.82	23.10	46.00	-22.90	AV
9	1.000	22.22	9.81	32.03	56.00	-23.97	QP
10	1.000	10.55	9.81	20.36	46.00	-25.64	AV
11	1.400	15.79	9.82	25.61	56.00	-30.39	QP
12	1.400	8.74	9.82	18.56	46.00	-27.44	AV
13	2.000	13.73	9.83	23.56	56.00	-32.44	QP
14	2.000	6.31	9.83	16.14	46.00	-29.86	AV
15	3.500	13.77	9.85	23.62	56.00	-32.38	QP
16	3.500	7.96	9.85	17.81	46.00	-28.19	AV
17	6.000	10.46	9.88	20.34	60.00	-39.66	QP
18	6.000	6.33	9.88	16.21	50.00	-33.79	AV
19	10.000	15.05	9.93	24.98	60.00	-35.02	QP
20	10.000	9.60	9.93	19.53	50.00	-30.47	AV
21	22.000	10.82	9.95	20.77	60.00	-39.23	QP
22	22.000	7.08	9.95	17.03	50.00	-32.97	AV
23	30.000	11.35	9.94	21.29	60.00	-38.71	QP
24	30.000	7.23	9.94	17.17	50.00	-32.83	AV

3.6 Photo during the test

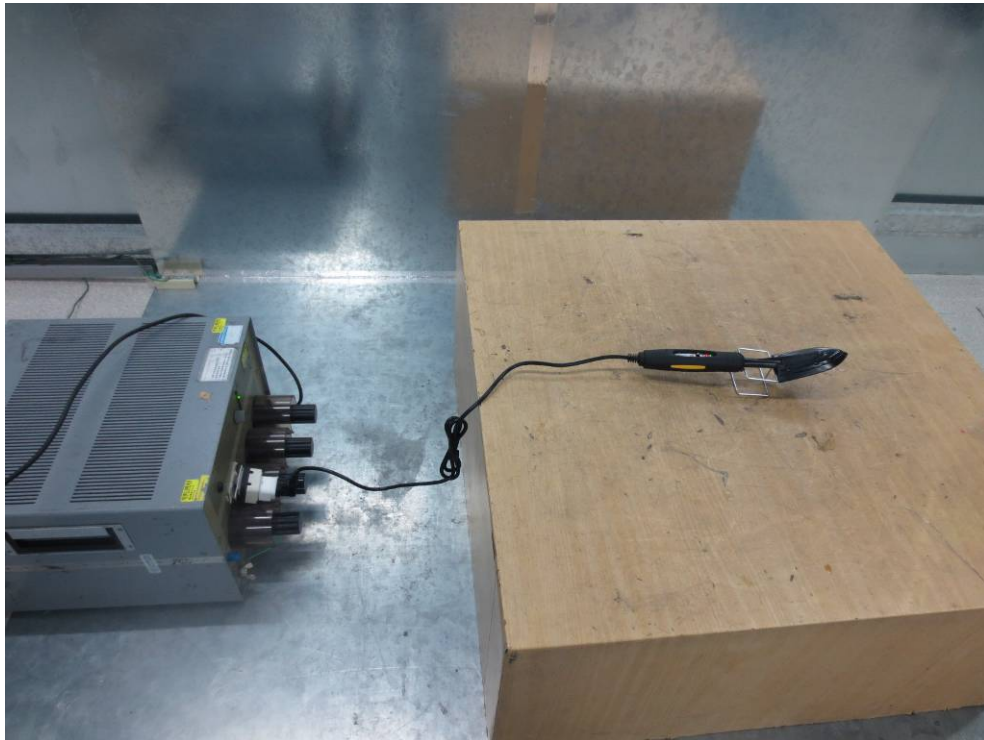

4. Radiated Emission Test

4.1 Limits of terminal disturbance voltage

Frequency range	Household and similar appliances		Tools					
			Rated motor power not exceeding 700W		Rated motor power not exceeding 700W		Rated motor power not exceeding 700W	
(MHz)	Quasi-peak (dB μ V)	Average (dB μ V)	Quasi-peak (dB μ V)	Average (dB μ V)	Quasi-peak (dB μ V)	Average (dB μ V)	Quasi-peak (dB μ V)	Average (dB μ V)
30 to 300	Increasing linearly with the frequency from							
	45 to 55	35 to 45	45 to 55	35 to 45	49 to 59	39 to 49	55 to 65	45 to 55

* If the limit for the measurement with the average detector is met when using a receiver with a quasi-peak detector, the equipment under test shall be deemed to meet both limits and the measurement using the receiver with an average detector need not be carrier out.

4.2 Test setup

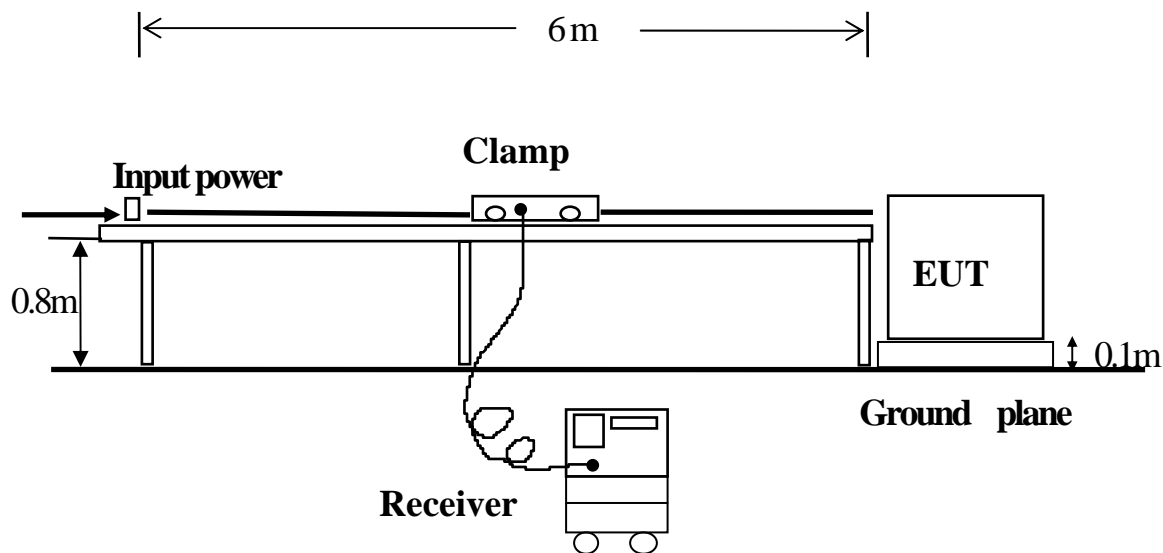

4.3 Environmental conditions

Test Date	Ambient Temperature	Relative Humidity	Atmospheric Pressure
Feb. 17, 2016	24.3 °C	53.2 %	1012 mbar

4.4 Description of the test

1. The reading on the measuring receiver is observed for about 15s each measurement; the highest readings shall be recorded with the exception of any isolated spike which shall be ignored.
2. The registered values shall be given at least at the following frequencies: 30MHz, 45MHz, 65MHz, 90MHz, 150MHz, 180MHz, 220MHz and 300MHz, these frequencies are to be subject to a tolerance of ± 5 MHz.

4.5 Test result

Judging from these data, it is reasonable to assume that the EUT would pass the test to the limits. And, according to the standard, the test was passed successfully.

EMC Log Sheet of Power Test – Main Power.

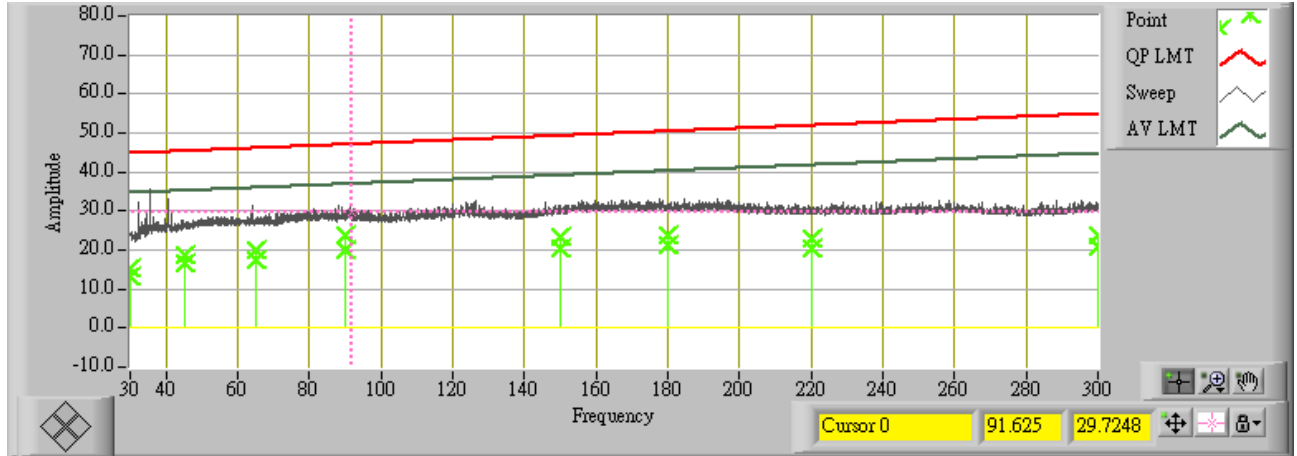

No.	Freq. (MHz)	Reading (dBpW)	Factor (dB)	Result (dBpW)	Limit (dBpW)	Margin (dB)	Remark
1	30.000	10.14	5.12	15.26	45.00	-29.74	QP
2	30.000	8.02	5.12	13.14	35.00	-21.86	AV
3	45.000	13.95	4.97	18.92	46.76	-27.84	QP
4	45.000	11.69	4.97	16.66	36.76	-20.10	AV
5	65.000	13.44	6.77	20.21	48.36	-28.15	QP
6	65.000	10.86	6.77	17.63	38.36	-20.73	AV
7	90.000	16.56	7.32	23.88	49.77	-25.90	QP
8	90.000	12.51	7.32	19.83	39.77	-19.95	AV
9	150.000	14.69	8.52	23.21	51.99	-28.78	QP
10	150.000	11.92	8.52	20.44	41.99	-21.55	AV
11	180.000	14.55	9.45	24.00	52.78	-28.78	QP
12	180.000	11.98	9.45	21.43	42.78	-21.35	AV
13	220.000	13.90	9.01	22.91	53.65	-30.74	QP
14	220.000	11.29	9.01	20.30	43.65	-23.35	AV
15	300.000	14.87	8.92	23.79	55.00	-31.21	QP
16	300.000	11.89	8.92	20.81	45.00	-24.19	AV

4.6 Photo during the test



5. Discontinuous Disturbance

5.1 Reference standard

EN 55014-1 : 2006 + A2 : 2011
 Electromagnetic compatibility (EMC)
 Part 1: Emission.

5.2 Test setup

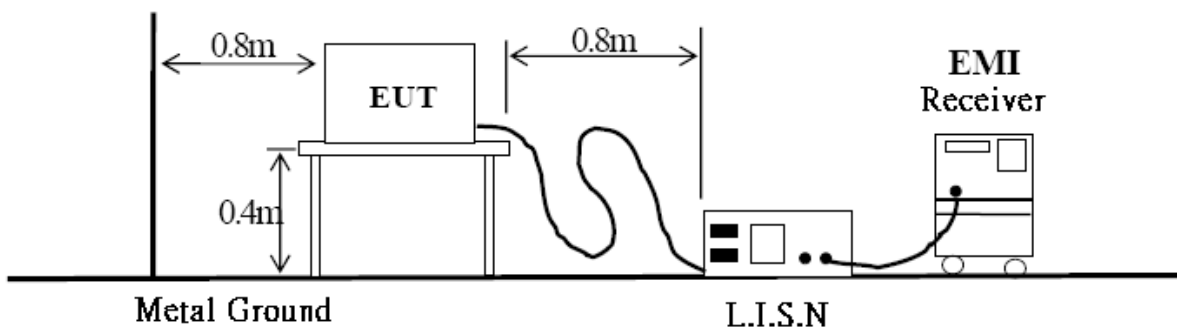

5.3 Environmental conditions

Test Date	Ambient Temperature	Relative Humidity	Atmospheric Pressure
Feb. 17, 2016	24.3 °C	53.2 %	1012 mbar

5.4 Description of the test

1. The test was carried out on the EUT broadly in accordance with EN 55014-1:2006 + A2:2011.
2. The minimum observation time T is obtained at both measuring frequencies in following way:
 - (1) the time to register 40 clicks, or , where relevant, 40 switching operations
 - (2) 120 min.
3. Measuring at 150kHz for the frequency range 14.8kHz to 500kHz and at 500kHz for the frequency range 500kHz to 30MHz.
4. For appliances which stop automatically, the duration of the minimum number of complete programs necessary to produce 40 clicks or, where relevant, 40 switching operations. When, 120 min. after the beginning of the test, 40 clicks have not been produced, the test is stopped at the end of the program in progress.
5. The formula $N=n_1/T$, n_1 is the number of clicks during the observation time T minutes, the formula $N=n_2xf/T$ where n_2 is the number of switching operations during the observation time T and f is a factor given in EN 55014-1.
6. The click limit L_q is attained by increasing the relevant limit L(continuous emission) with :
$$44 \text{ dB} \quad \text{for } N < 0.2 \text{ or}$$
$$20 \log(30/N) \text{ dB} \quad \text{for } 0.2 \leq N < 30$$
7. Appliances which fulfill the following conditions shall be deemed to comply with the limits: - the click rate is not more than 5, none of the caused clicks has a duration longer than 20 ms, 90% of the caused clicks have a duration less than 10 ms.
8. The appliance is assessed for compliance with the higher limit L_q in accordance with the upper quartile method, the appliance being tested for a time not less than the minimum observation time T.
9. If the click rate N is determined from the number of clicks, the appliance under test shall be deemed to comply with limit if not more than a quarter of the number of clicks registered during the observation time T exceeds the click limit L_q .
10. If the click rate N is determined from the number of switching operations, the appliance under test shall be deemed to comply with the limit if not more than a quarter of the number of switching operations registered during the observation time T produce click exceeding the click limit L_q .

5.5 Test result

The following pages show the results of discontinuous disturbance test.

Judging from these data, it is reasonable to assume that the EUT would pass the test to the limits defined in EN 55014-1:2006.

5.5.1 Discontinuous Disturbance Result

- (1) Phase : L1
- (2) Frequency : 150kHz
- (3) Limit for Continuous disturbance level :66dB
- (4) First time test.

1	2	3	4	5	6	7	8	9	10	11	12	13	14	15	16	17	18	19	20
—	—	—	—	—	—	—	—	—	—	—	*	—	—	—	—	—	—	—	—
21	22	23	24	25	26	27	28	29	30	31	32	33	34	35	36	37	38	39	40
—	—	—	—	—	—	—	—	—	*	—	—	—	—	—	—	—	—	—	—

“ * ” is click — ” is the discontinuous disturbance(not exceeding the limit for continuous disturbance)

- (5) Total time of run (T) = **120** min.
- (6) Total number of clicks(n1) = **2**

$$N = n1 / T = 2/120 = \mathbf{0.0167}$$
- (7) Click rate (N) less than 5 and it's duration less than 10 ms, comply the limit.

5.5.2 Discontinuous Disturbance Result

- (1) Phase : L1
- (2) Frequency : 500kHz
- (3) Limit for Continuous disturbance level : 56dB(μ V)
- (4) First time test

1	2	3	4	5	6	7	8	9	10	11	12	13	14	15	16	17	18	19	20
—	—	—	—	—	—	—	—	—	—	—	—	—	—	—	—	—	—	—	*
21	22	23	24	25	26	27	28	29	30	31	32	33	34	35	36	37	38	39	40
—	—	—	—	*	—	—	—	—	—	—	—	—	—	—	—	—	—	—	—

“ * ” is click — ” is the discontinuous disturbance(not exceeding the limit for continuous disturbance)

- (5) Total time of run (T) = **120** min.
- (6) Total number of clicks(n1) = **2**

$$N = n1 / T = 2/120 = \mathbf{0.0167}$$
- (7) Click rate (N) less than 5 and it's duration less than 10 ms, comply the limit.

5.5.3 Discontinuous Disturbance Result

- (1) Phase : N
- (2) Frequency : 150kHz
- (3) Limit for Continuous disturbance level : 66dB(μ V)
- (4) First time test

1	2	3	4	5	6	7	8	9	10	11	12	13	14	15	16	17	18	19	20
—	—	—	—	—	—	—	—	—	—	—	—	*	—	—	—	—	—	—	—
21	22	23	24	25	26	27	28	29	30	31	32	33	34	35	36	37	38	39	40
—	—	—	—	—	—	—	—	—	—	—	—	*	—	—	—	—	—	—	—

“ * ” is click — ” is the discontinuous disturbance(not exceeding the limit for continuous disturbance).

- (5) Total time of run (T) = **120** min.
- (6) Total number of clicks (n1) = **2**

$$N = n1 / T = 2/120 = \mathbf{0.0167}$$
- (7) Click rate (N) less than 5 and it's duration less than 10 ms, comply the limit.

5.5.4 Discontinuous Disturbance Result

- (1) Phase : N
- (2) Frequency : 500kHz
- (3) Limit for Continuous disturbance level : 56dB(μ V)
- (4) First time test

1	2	3	4	5	6	7	8	9	10	11	12	13	14	15	16	17	18	19	20
—	—	—	—	—	—	—	—	—	—	—	—	—	—	—	*	—	—	—	—
21	22	23	24	25	26	27	28	29	30	31	32	33	34	35	36	37	38	39	40
—	—	—	—	—	—	—	—	—	—	—	—	*	—	—	—	—	—	—	—

“ * ” is click — ” is the discontinuous disturbance(not exceeding the limit for continuous disturbance).

- (5) Total time of run (T) = **120** min.
- (6) Total number of clicks (n1) = **2**

$$N = n1 / T = 2/ 120 =\mathbf{0.0167}$$
- (7) Click rate (N) less than 5 and it's duration less than 10 ms, comply the limit.

5.6 Photo during the test

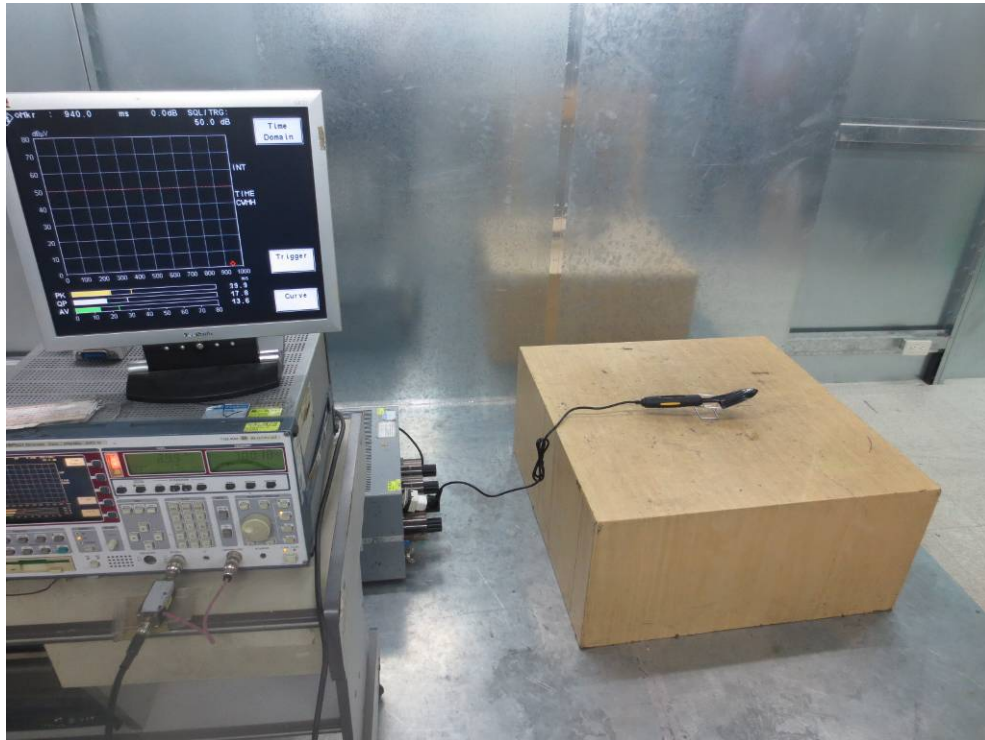

6. Harmonics on AC Mains

6.1 Limits for harmonic current emission (Class A)

Harmonic order n	Maximum permissible harmonic current A
Odd harmonic	
3	2.30
5	1.14
7	0.77
9	0.40
11	0.33
13	0.21
$15 \leq n \leq 39$	$0.15 \times 15/n$
Even harmonic	
2	1.08
4	0.43
6	0.30
$8 \leq n \leq 40$	$0.23 \times 8/n$

6.2 Test setup

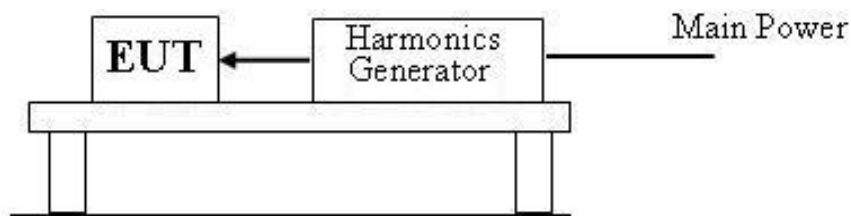

6.3 Environmental conditions

Test Date	Ambient Temperature	Relative Humidity	Atmospheric Pressure
Feb. 17, 2016	24.3 °C	53.2 %	1012 mbar

6.4 Description of the test

1. The EUT was put on a desk and operated to produce the maximum harmonic components under normal operating conditions for each successive harmonic component in turn.
2. The test was repeated when the EUT was in running state.

6.5 Test result

The following pages show the results with the measurement data of the test. There no limits exceeded. And, according to the standard, the test was passed successfully.

Average harmonic current results

Hn	leff [A]	leff [%]	Limit [A]	Result
1	23.735E-3	100.000		
2	1.330E-3	5.603	1.08	PASS
3	11.413E-3	48.084	2.30	PASS
4	2.460E-3	10.363	430.00E-3	PASS
5	10.548E-3	44.439	1.14	PASS
6	1.183E-3	4.985	300.00E-3	PASS
7	11.377E-3	47.934	770.00E-3	PASS
8	1.557E-3	6.562	230.00E-3	PASS
9	9.934E-3	41.853	400.00E-3	PASS
10	949.773E-6	4.002	184.00E-3	PASS
11	9.218E-3	38.838	330.00E-3	PASS
12	1.385E-3	5.837	153.33E-3	PASS
13	8.404E-3	35.409	210.00E-3	PASS
14	1.093E-3	4.604	131.43E-3	PASS
15	6.993E-3	29.461	150.00E-3	PASS
16	937.518E-6	3.950	115.00E-3	PASS
17	5.575E-3	23.490	132.35E-3	PASS
18	1.194E-3	5.032	102.22E-3	PASS
19	4.425E-3	18.644	118.42E-3	PASS
20	677.145E-6	2.853	92.00E-3	PASS
21	3.401E-3	14.329	160.71E-3	PASS
22	1.089E-3	4.588	83.64E-3	PASS
23	2.389E-3	10.064	146.74E-3	PASS
24	620.324E-6	2.614	76.66E-3	PASS
25	1.632E-3	6.878	135.00E-3	PASS
26	992.289E-6	4.181	70.77E-3	PASS
27	1.006E-3	4.238	124.99E-3	PASS
28	590.598E-6	2.488	65.71E-3	PASS
29	960.420E-6	4.046	116.39E-3	PASS
30	609.213E-6	2.567	61.33E-3	PASS

Average harmonic current results

Hn	leff [A]	leff [%]	Limit [A]	Result
31	868.048E-6	3.657	108.87E-3	PASS
32	558.637E-6	2.354	57.50E-3	PASS
33	1.318E-3	5.553	102.27E-3	PASS
34	556.734E-6	2.346	54.12E-3	PASS
35	1.313E-3	5.531	96.44E-3	PASS
36	563.729E-6	2.375	51.11E-3	PASS
37	1.550E-3	6.532	91.21E-3	PASS
38	531.824E-6	2.241	48.42E-3	PASS
39	1.431E-3	6.029	86.53E-3	PASS
40	764.625E-6	3.221	46.00E-3	PASS

6.6 Photo during the test

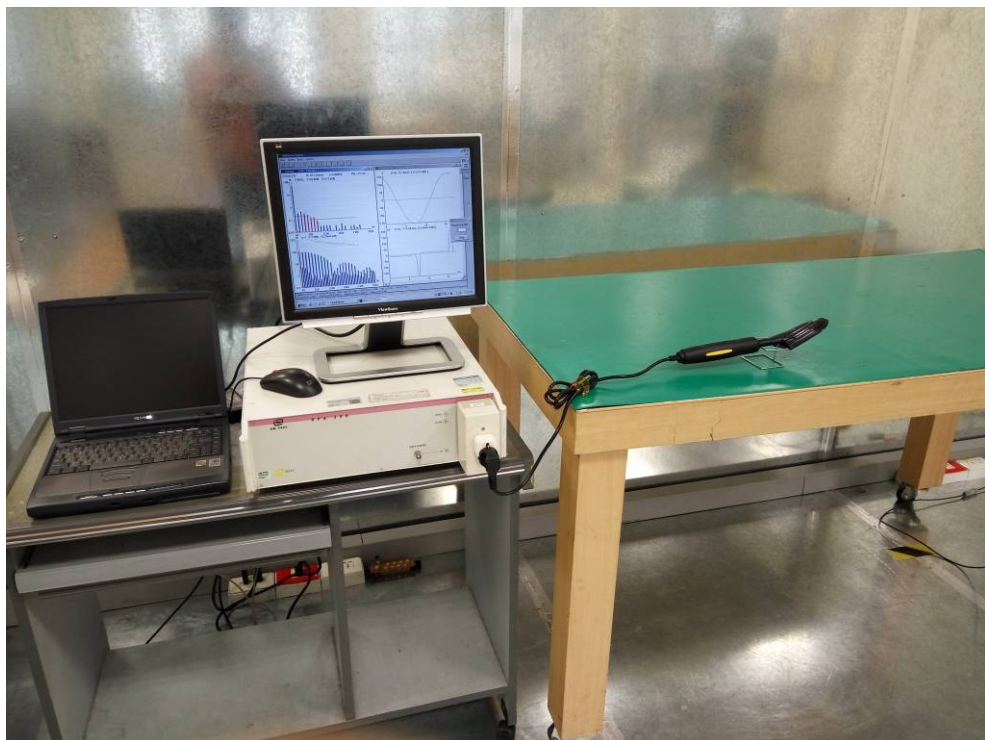

7. Voltage Fluctuation on AC Mains

7.1 Limits

Test Item	Limit	Note
P_{ST}	1.0	P_{ST} means short-term flicker
P_{IT}	0.65	P_{IT} means long-term flicker
$d(t)$	500ms	$d(t)$ means maximum time exceed 3.3%
$d_C(\%)$	3.3%	$d_C(\%)$ means relative steady state voltage change
$d_{max}(\%)$	4%	$d_{max}(\%)$ mean maximum relative voltage change

7.2 Test setup

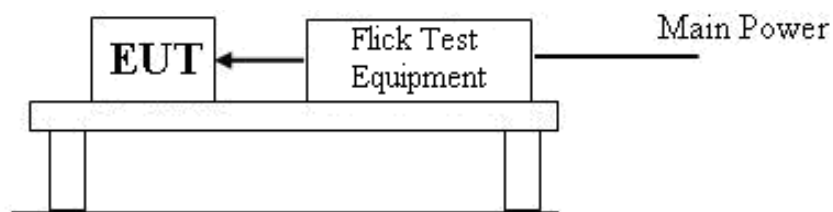

7.3 Environmental conditions

Test Date	Ambient Temperature	Relative Humidity	Atmospheric Pressure
Feb. 17, 2016	24.3 °C	53.2 %	1012 mbar

7.4 Description of the test

1. The EUT was put on a desk. The maximum voltage fluctuations were found during motor starting.
2. The test was repeated when the EUT was in normal operating condition. Switch ON/OFF the main power to determine the maximum voltage fluctuations during motor starting.

7.5 Test result

The following show the results with voltage fluctuations. Judging from these data, it is reasonable to assume that the EUT would pass the test to the limits.

Maximum Flicker Results

	EUT Values	Limit	Result
Pst	0.140	1.00	PASS
Plt	0.140	0.65	PASS
dc [%]	0.130	3.30	PASS
dmax [%]	0.637	4.00	PASS
dt [s]	0.000	0.50	PASS

7.6 Photo during the test

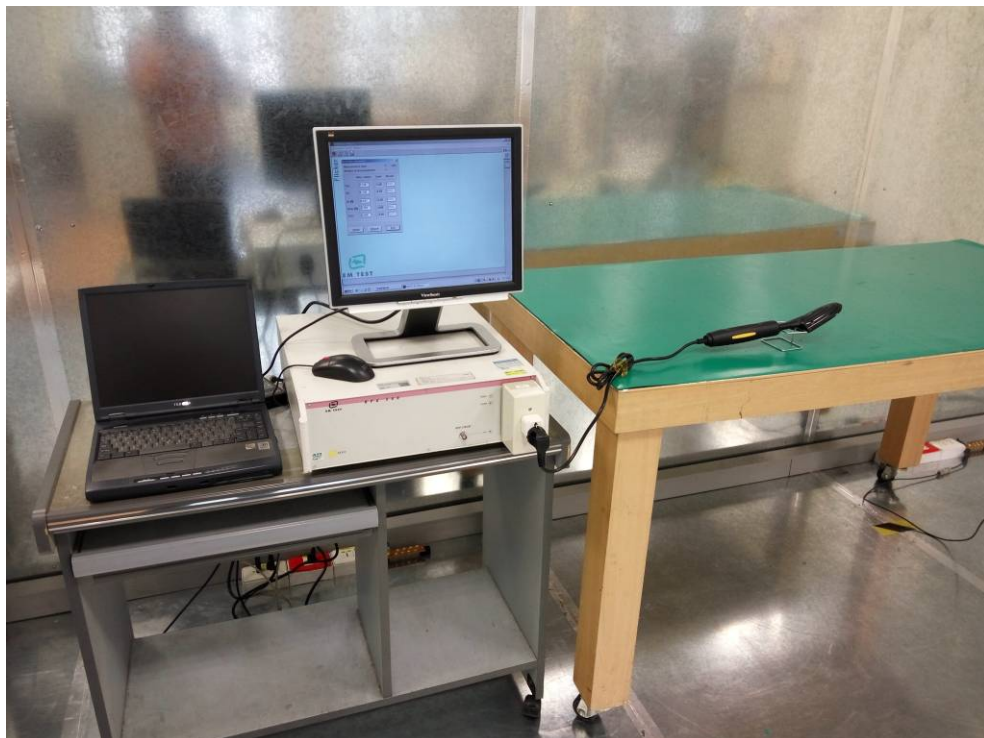

8. Electrostatic Discharge Immunity Test

8.1 Test specification and performance criteria

Test Port	Test Specification	Units	Basic Standard	Remarks	Performance Criteria
Enclosure	±4 Contact ±8 Air Discharge	kV (Charge Voltage)	EN 61000-4-2	Note 1	B

Note 1 : The 4kV contact discharge shall be applied to conductive accessible parts. Metallic contacts, such as in battery compartments or in socket outlets are excluded from this requirement.

8.2 Test setup

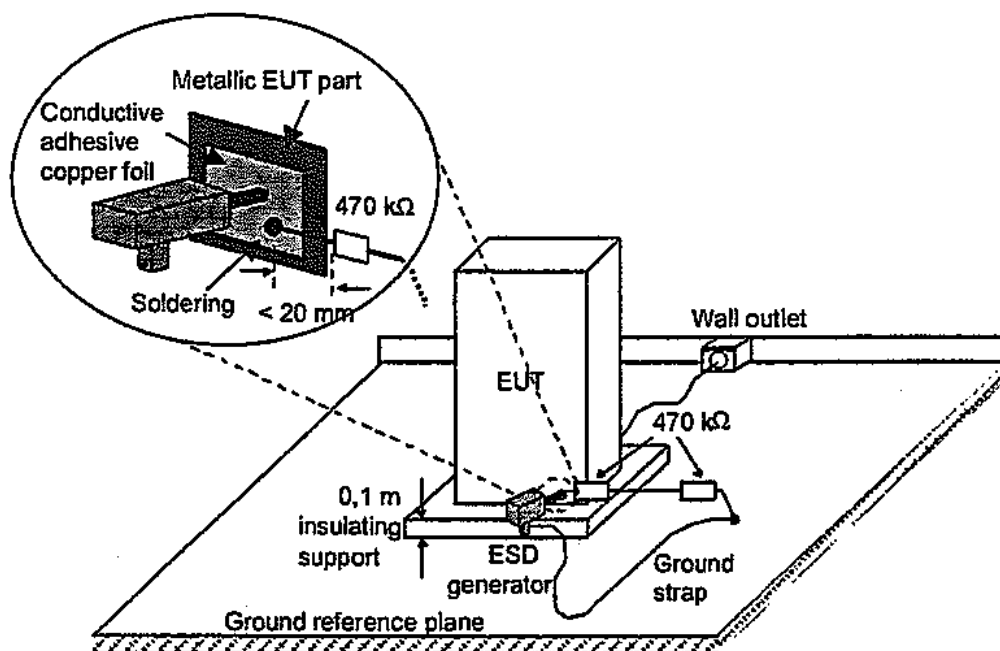

8.3 Environmental conditions

Test Date	Ambient Temperature	Relative Humidity	Atmospheric Pressure
Feb. 18, 2016	24.2 °C	55.3 %	1006 mbar

8.4 Description of the test

1. Contact discharge is the preferred test method. 20 discharges (10 with positive and 10 with negative polarity) shall be applied on each accessible metal part of the enclosure. In case of a non-conductive enclosure, discharges shall be applied on horizontal and vertical coupling planes. Air discharge shall be used where contact discharges cannot be applied.
2. The performance was observed according to the intentional movement defined by the manufacturer and any discrepancies were noted.

8.5 Test result

The following pages show the process of testing in both general operation mode and idle state. It can be seen that there were no unintentional movement on the EUT. And, according to the standard, the test was passed successfully.

EMC LOG SHEET OF ESD TEST

Test Point	Test Method		
	Air	Contact	H/VCP
	1. Case 2. Knob 3. LED light 4. Handle	Screws	Four Sides of EUT

Severity Level	Requirement			Performance			Test Result
	Air	Contact	H/VCP	Air	Contact	H/VCP	
±4kV	B	B	B	A	A	A	PASS
±8kV	B	N/R	N/R	A	N/R	N/R	PASS

Note :

1. N/R means no requirement.
2. Test points :
 - 2.1. air discharge for non- conducted parts.
 - 2.2. contact discharge for conducted parts.

8.6 Photo during the test



9. Electrical Fast Transient/Burst Immunity Test

9.1 Test specification and performance criteria

AC input and AC output power ports

Phenomena	Test Specification	Units	Basic Standard	Performance Criteria
Fast Transients	± 1 5/50 5	kV (Peak) Tr / Td ns Rep. Frequency kHz	EN 61000-4-4	B

9.2 Test setup

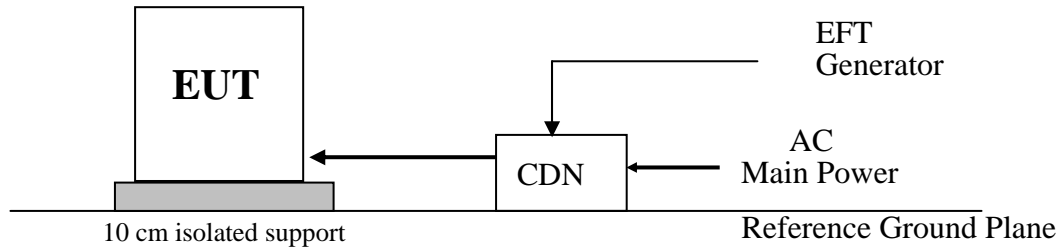

9.3 Environmental conditions

Test Date	Ambient Temperature	Relative Humidity	Atmospheric Pressure
Feb. 18, 2016	24.2 °C	55.3 %	1006 mbar

9.4 Description of the test

1. The test was setup by coupling/decoupling network and a series of positive and negative polarity transients was direct injection on AC Input power cable. The performance was observed according to the intentional movement defined by the manufacturer and any discrepancies were noted.
2. Fast transient tests are carried out for 1 minutes with a positive and for 1 minutes with negative polarity.

9.5 Test result

The following pages show the process of testing in both general operation mode and idle state. It can be seen that there were no unintentional movements on the EUT. And, according to the standard, the test was passed successfully.

EMS Log Sheet of EFT Test

Coupling Mode Severity Level	Requirement	Performance	Test Result
	AC Line	AC Line	
±0.5kV	B	A	PASS
±1.0kV	B	A	PASS
Note : N/R means no requirement.			

9.6 Photo during the test

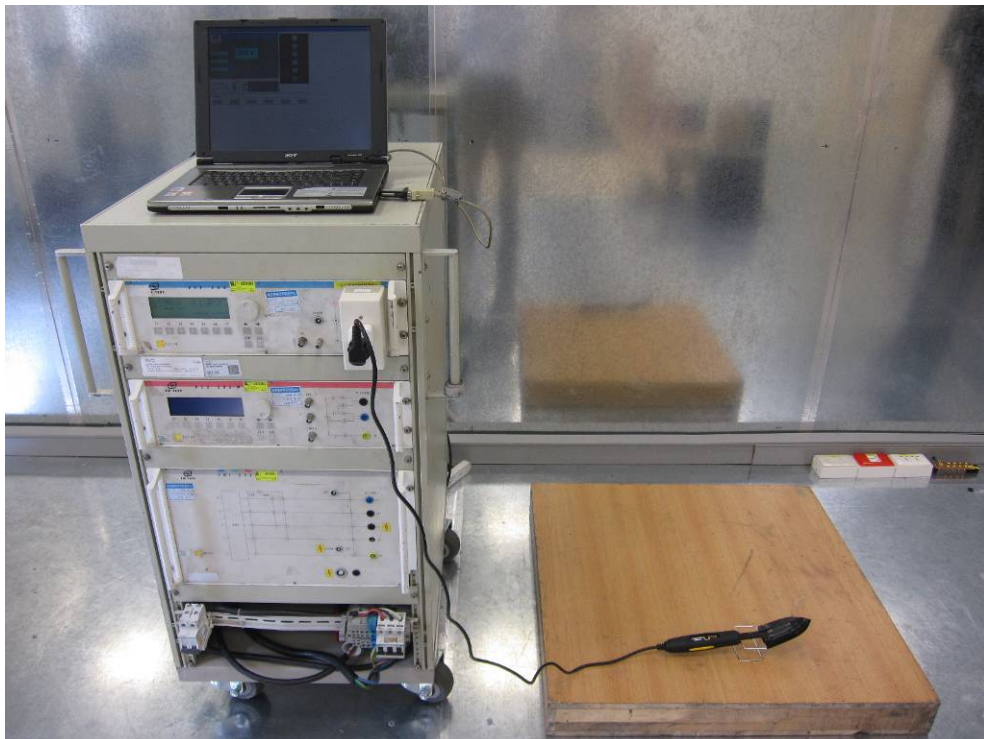

10. Immunity Test of Conducted Disturbances Induced by Radio—Frequency Fields

10.1 Test specification and performance criteria

AC input and AC output power ports

Phenomena	Test Specification	Units	Basic Standard	Performance Criteria
Radio-Frequency Common Mode Amplitude Modulated.	0.15-230 3 80 150	MHz V(rms) (Unmodulated,rms) % AM (1kHz) Source Impedance Ω	EN 61000-4-6	A

10.2 Test setup

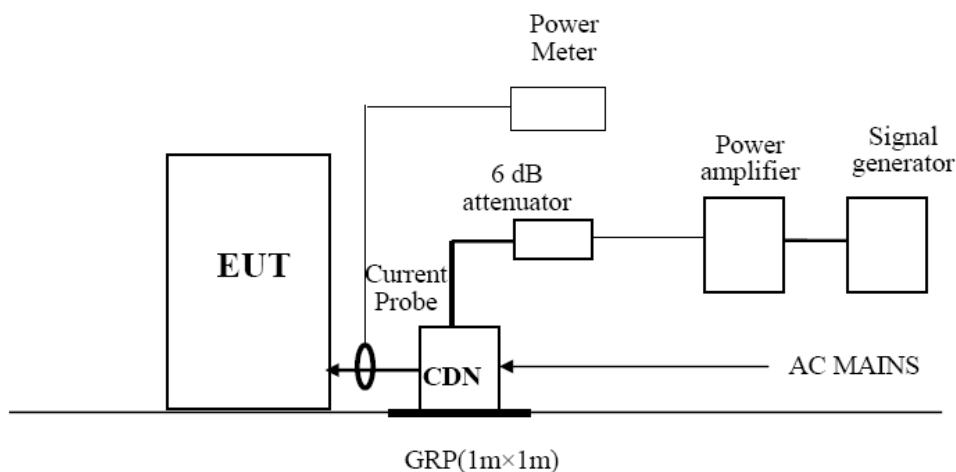

10.3 Environmental conditions

Test Date	Ambient Temperature	Relative Humidity	Atmospheric Pressure
Feb. 18, 2016	24.2 °C	55.3 %	1006 mbar

10.4 Description of the test

1. During the test, the frequency range was swept from 0.15 to 230 MHz incrementally with 1% step size of each frequency. The test signal was 80 % amplitude modulated with 1 kHz sine wave.
2. The performance was observed according to the intentional movement defined by the manufacturer and any discrepancies were noted.
3. The test was repeated when the EUT was in idle (standby) and general operation state.
4. The other cables are < 3m length. As a result, it is unnecessarily for this item of the test.

10.5 Test result

The following pages show the process of testing in both general operation mode and idle state. It can be seen that there were no unintentional movement on the EUT. And, according to the standard, the test was passed successfully.

Results of CS Test

Description	Requirement	Performance	Test Result
AC Input Power Cable (L1, L2)	A	A	PASS
Note : N/R means no requirement.			

10.6 Photo during the test

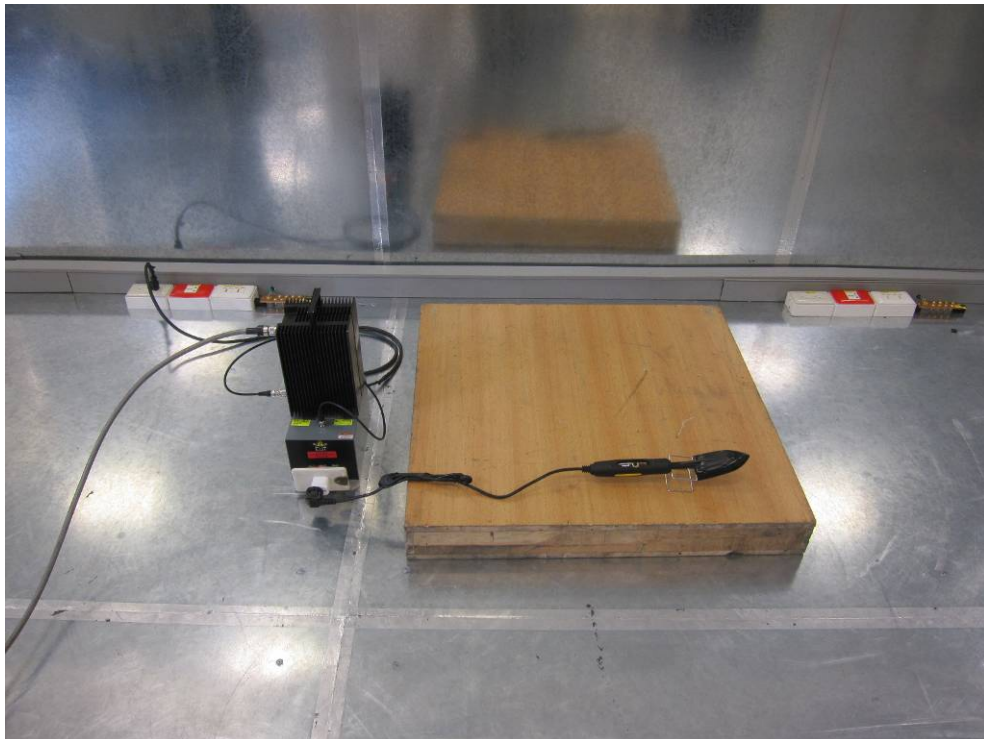

11. Surge Immunity Test

11.1 Test specification and performance criteria

Test Port	Test Specification	Units	Basic Standard	Performance Criteria
a.c. Power Port	1.2/50(8/20) ±1 ±2	Tr/Td μ s kV kV	EN 61000-4-5	B

11.2 Test setup

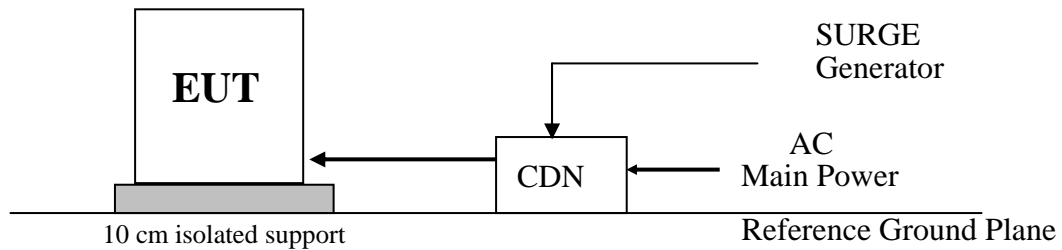

11.3 Environmental conditions

Test Date	Ambient Temperature	Relative Humidity	Atmospheric Pressure
Feb. 18, 2016	24.2 °C	55.3 %	1006 mbar

11.4 Description of the test

1. Overview 5 negative and 5 positive Impulses and Source impedance generator :line to line= 2Ω , line /neutral to earth= 12Ω . Phase shifting in between $0^{\circ}\sim 360^{\circ}$ versus the A.C. line phase angle and steps is 90° .
2. The performance was observed according to the intentional movement defined by the manufacturer and any discrepancies were noted.
3. The test was repeated when the EUT was in idle (standby) and general operation state.
4. The other cables are $< 30\text{m}$ length. As a result, it is unnecessarily for this item of the test.

11.5 Test result

The following pages show the process of testing in both general operation mode and idle state. It can be seen that there were no unintentional movement on the EUT, And, according to the standard, the test was passed successfully.

Results of Surge Test

Severity Level	Requirement		Performance		Test Result
	AC Line - Line	AC Line - Ground	AC Line - Line	AC Line - Ground	
± 1.0kV	B	B	A	A	PASS
± 2.0kV	N/R	B	N/R	A	PASS
Note : N/R means no requirement.					

11.6 Photo during the test

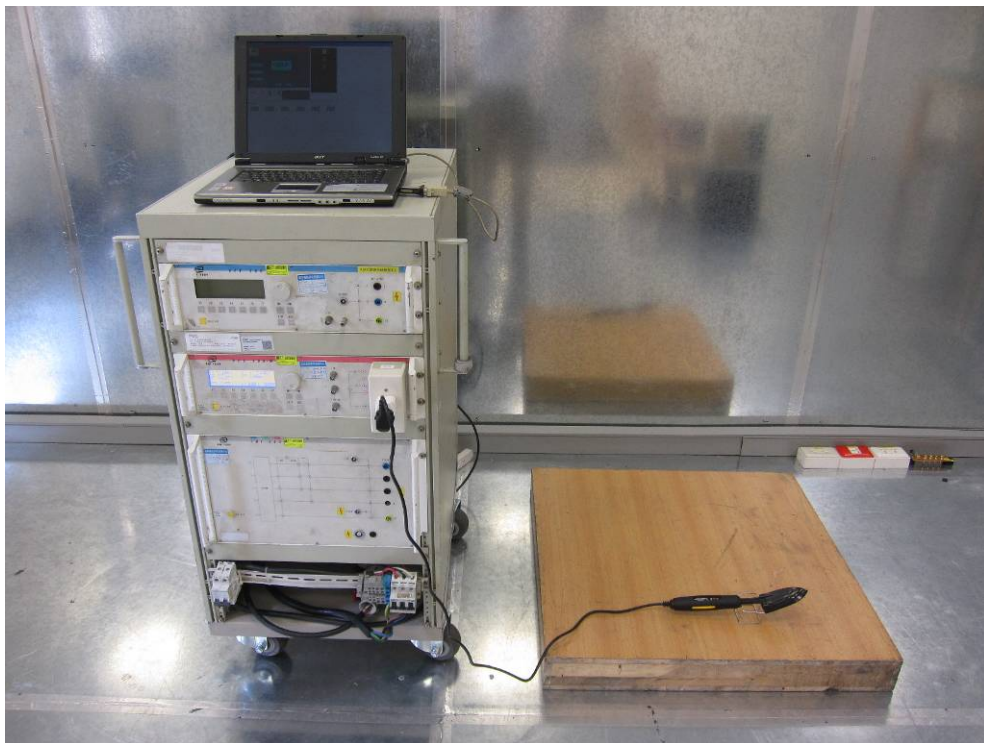

12. Voltage Dip and Voltage Variations Immunity Test

12.1 Test specification and performance criteria

Phenomena	Test Level IN % Rated Voltage	Duration (in periods of the Rated Frequency)	Performance Criteria
Voltage Dips	5	5s	C
Voltage Interruptions	40	1s	C
Voltage Interruptions	40	100ms	C
Voltage Interruptions	70	10ms	B

12.2 Test setup

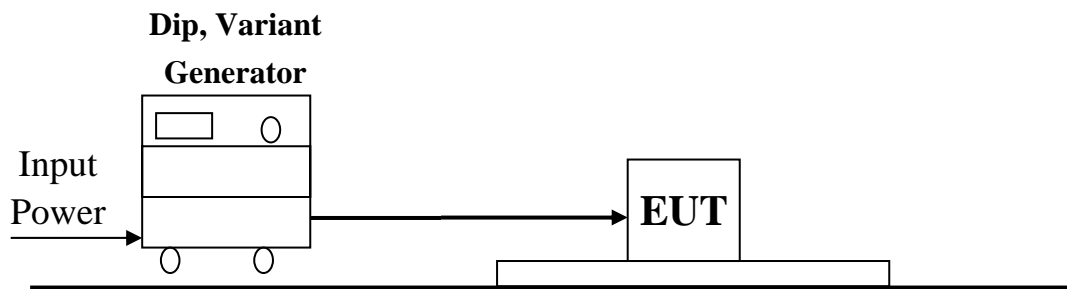

12.3 Environmental conditions

Test Date	Ambient Temperature	Relative Humidity	Atmospheric Pressure
Feb. 18, 2016	24.2 °C	55.3 %	1006 mbar

12.4 Description of the test

1. The EUT shall be tested for each selected combination of test level and duration with a sequence of three dip/interruptions with intervals of 10s minimum. Abrupt changes in supply voltage shall occur at zero crossings of the voltage, and additional angles selected form 0°~360°, step is 45°.
2. The performance was observed according to the intentional function defined by the manufacturer and any discrepancies were noted.
3. The test was repeated when the EUT was in running state.

12.5 Test result

The following show the process of testing in auto mode or running state. It can be observed that there were no unpredictable function happened during test.

Test Level in % of Rated Voltage	Test Duration (ms)	Numbers of Applications	Observation Criteria	Test Results
5	5000	3	C	PASS
40	1000	3	C	PASS
40	100	3	A	PASS
70	10	3	A	PASS

12.6 Photo during the test



ATTACHMENT

Photograph of EUT

1. Overview of EUT



2. Overview of EUT



3. Overview of EUT



4. Overview of EUT



5. Overview of EUT



6. Overview of EUT



7. Overview of EUT



8. Overview of EUT



9. Inside of EUT



10. Inside of EUT



11. Inside of EUT

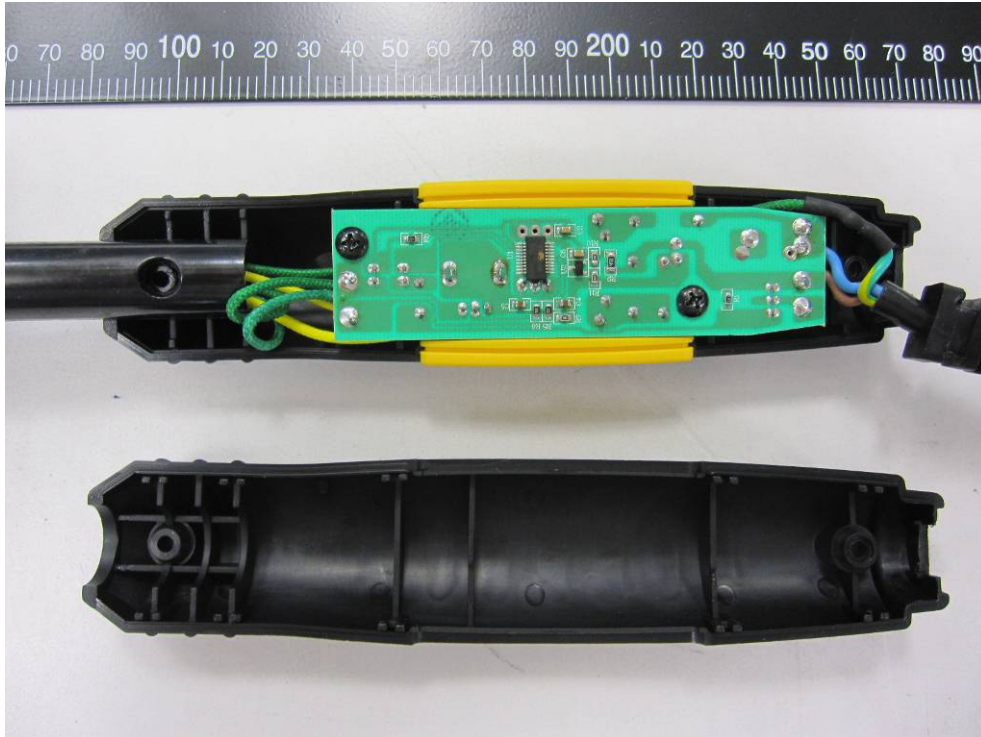

12. Inside of EUT

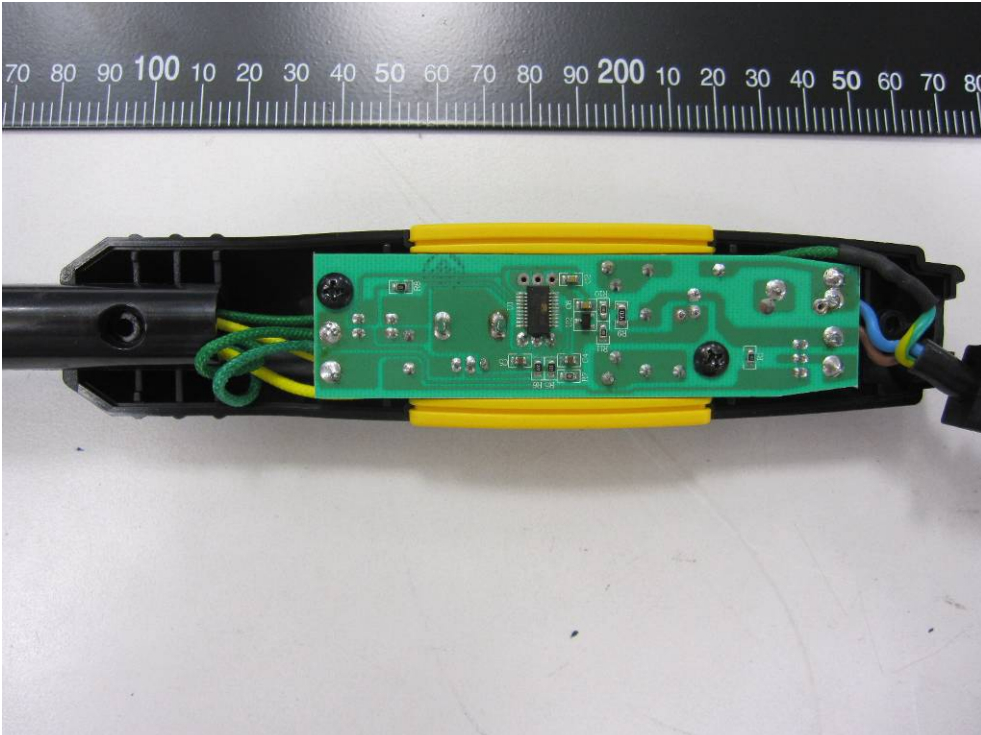

13. Inside of EUT

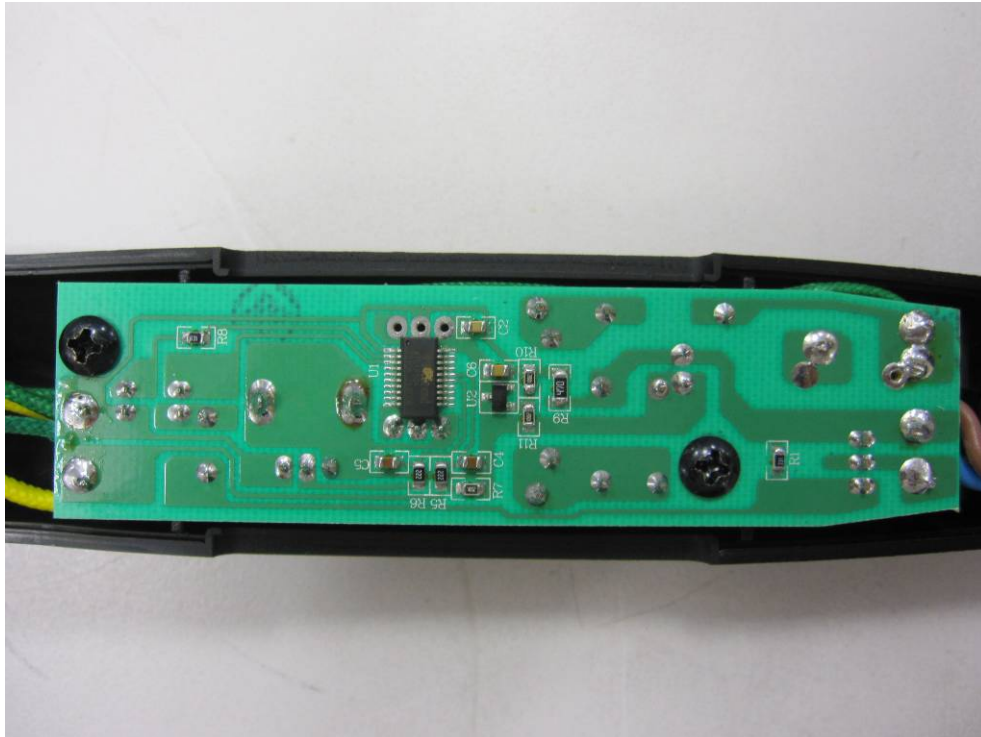

14. Inside of EUT

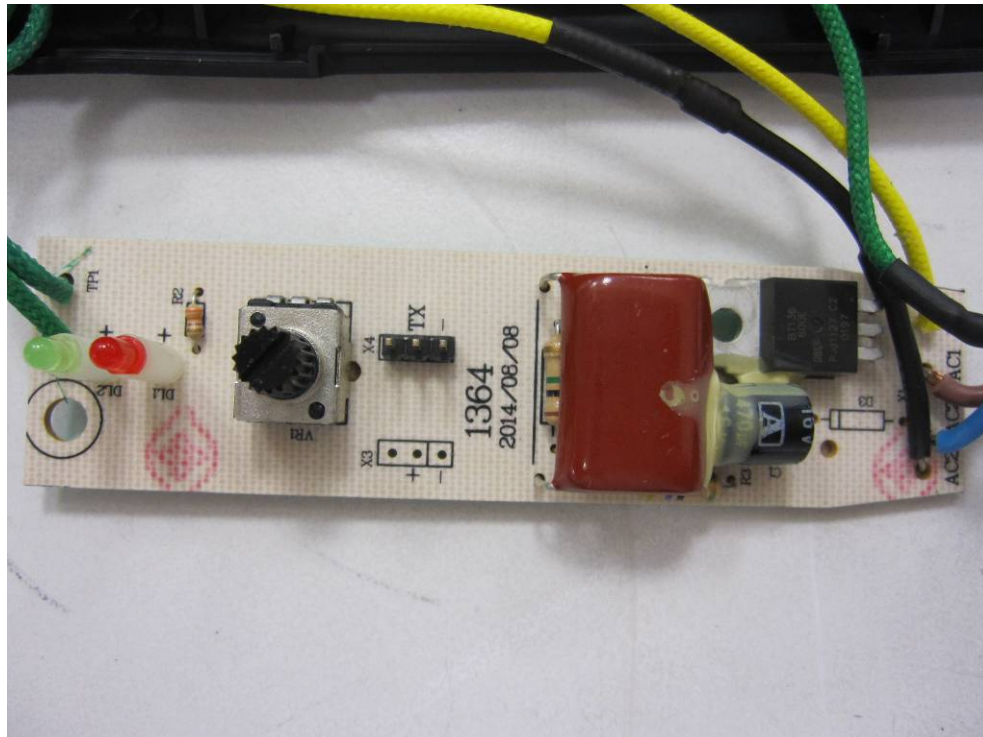

ATTACHMENT

Electronic Diagram of EUT

Electronic Diagram

